

FEATURES:

- Gasketing package provided.
- Insulation: 1"-1.5 lb. Density.
- Estimated Weight: 72 Lbs.
- All Galvanized Welded Construction.

CURB ADAPTER

EXISTING RHEEM:
RRNL-B, RRPL-B, RRRL-B 024-060; RQKA, RQMA, RQNA, RRMA 018-048; RRKA, RSKA, 018-060; RRNA 024-060

FOR YORK UNITS:
PCG4A, PCE4A 024- 042/ PHE4A, PHG4A 024- 030

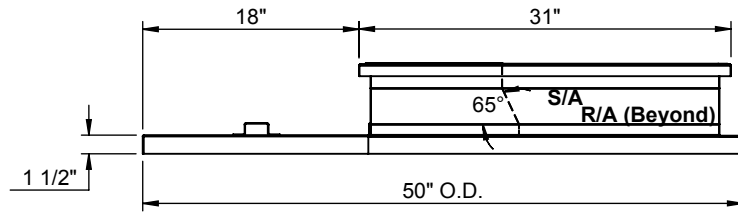

FRONT VIEW

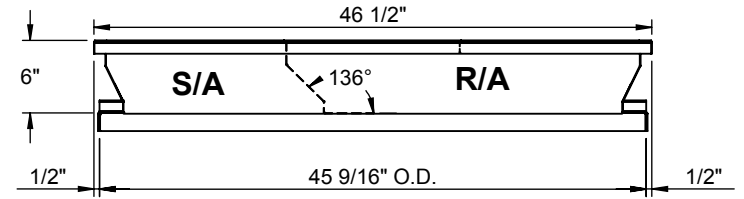

RIGHT VIEW

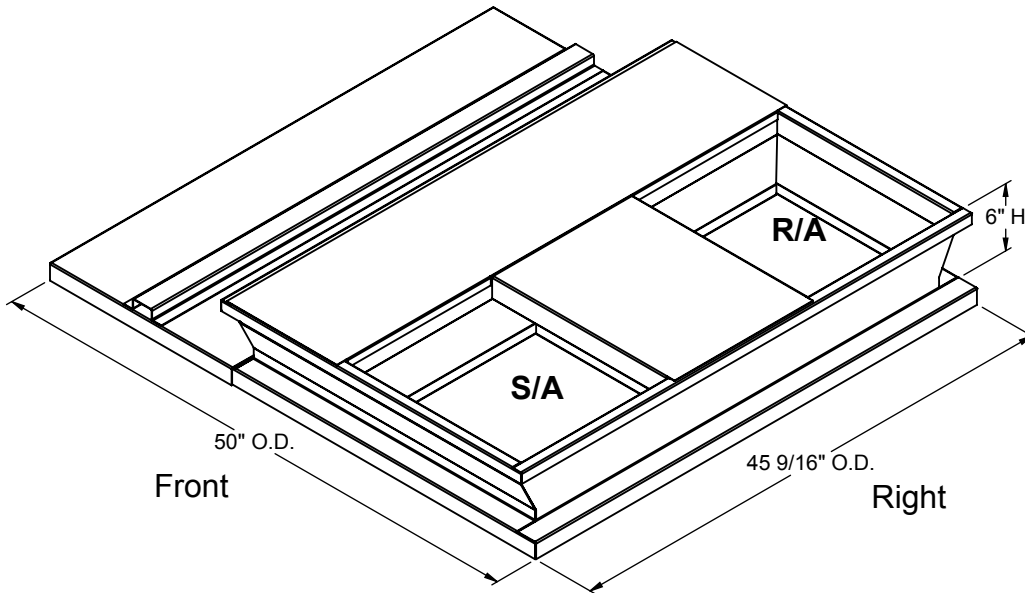

ISOMETRIC VIEW

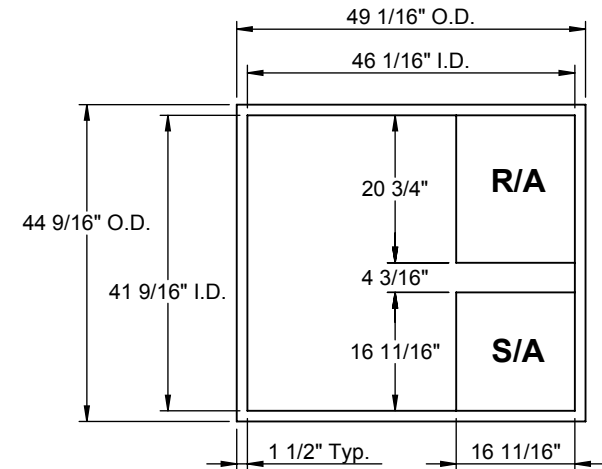

EXISTING CURB



3847 WABASH DRIVE
MIRA LOMA, CA 91752

PHONE (951) 685-1101
FAX (619) 872-9799

SUBMITTED TO: _____
COMPANY: _____
JOB NAME: _____
EQUIPMENT: _____
NOTES: _____

FORM NO: _____
DATE: 2/20/2017

PART NUMBER:
CA-LXS-RHM07
REV: -
DRAWN BY:
ALL