

For wood, concrete and steel attachments see Roof Anchorage Detail, Form No. CB-25.

**CALCULATED WIND AND SEISMIC  
ROOF CURBS FOR YORK UNITS  
SERIES 20/ LARGE SUNLINE- SHORT RAIL**

ProVent P/N	A	WEIGHT	CALCULATED KIT P/N	WEIGHT
80-268-1914	14"	230 Lbs	80-266-1914	98 Lbs
80-268-1918	18"	290 Lbs	80-266-1918	136 Lbs

Will conform to wind load code requirements for knock-down or pre-assembled application. (Contact factory for assembled version.)

**ZF 180**

Meets wind, seismic requirements for the following codes:  
FBC 2017  
based on ASCE 7-10.

**Wind:**  
185 mph exposure D category III or IV building, max BLDG height: 60 ft  
Kzt=1.66max

**Seismic:**  
Sds=0.30 max  
Sd1=0.187 max  
Site Class E  
Importance Factor: Ip=1.5

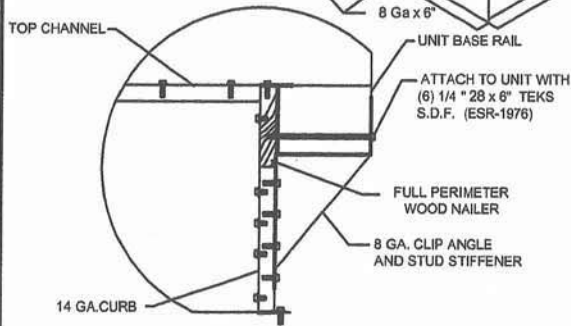
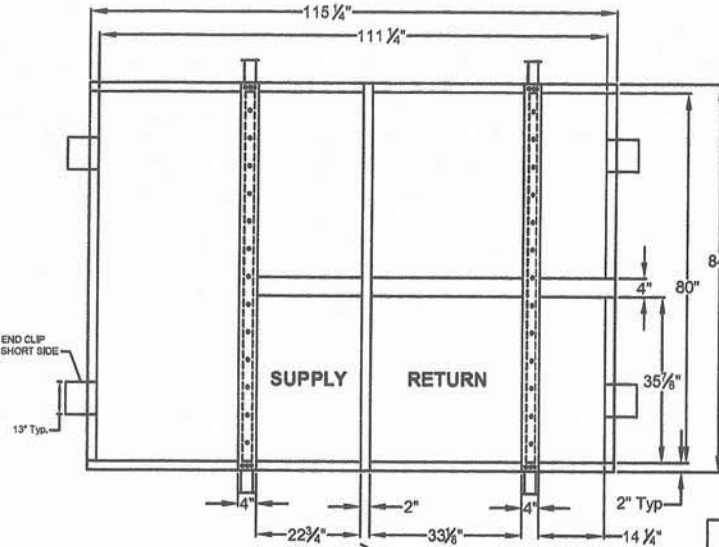
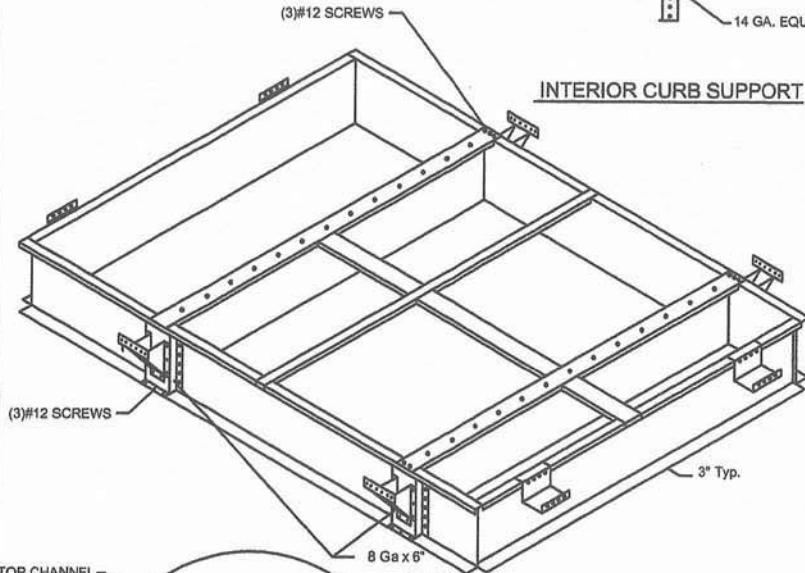
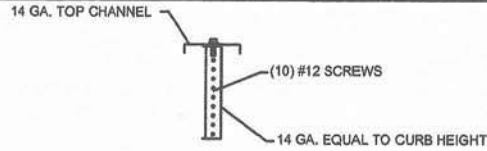

**HOLD DOWN DETAIL**

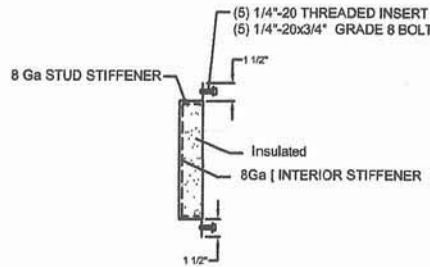

**STUD STIFFENER**

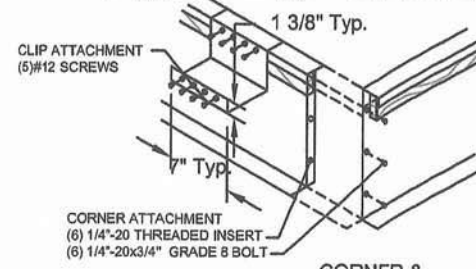

**CORNER & END CLIP DETAIL**

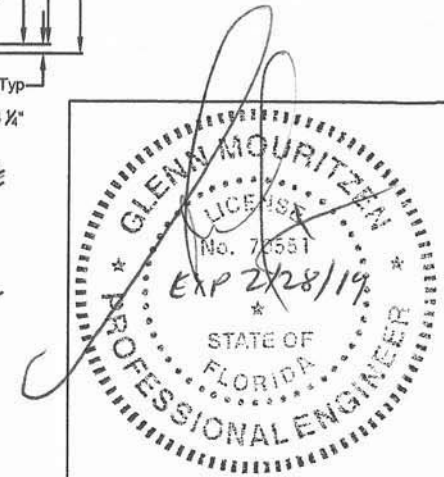

3847 WABASH DR.  
MIRA LOMA, CA 91725

PHONE (951) 685-1101  
FAX (619) 872-9799

SUBMITTED TO: \_\_\_\_\_  
COMPANY: \_\_\_\_\_  
JOB NAME: \_\_\_\_\_  
EQUIPMENT: \_\_\_\_\_  
NOTES: \_\_\_\_\_

FORM NO:  
CBKD-92

DATE:  
6/12/18

PART NUMBER:  
80-268-19

REV:  
4

DRAWN BY:  
JG